

# **Functional Specification of Administration Database for Mobile Number Portability**



**Communications Authority  
Hong Kong**

### Revision History

Issue No.	Date Issued	Note
1	August 1998	Issued by the former Telecommunications Authority (TA) for the initial launch of Mobile Number Portability (MNP).
2	November 1999	Revised and issued by the former TA after the successful launch of MNP
3	August 2000	Issued by the former TA after refinements
4	February 2001	Issued by the former TA after the successful implementation of electronic documents to replace fax transaction.
5	January 2003	Revised and issued by the former TA after introduction of MVNO and for clarification of the procedures for relinquishment of ported number
6	December 2013	Consequential amendments as a result of establishment of the Communications Authority (CA) on 1 April 2012.
7	November 2016	Revised the size of the field of total number of records transferred [✂ ] (Sections 5 and 6) and MAs' names/operators' names/network codes were replaced with generic ones in the examples throughout the whole document.

# Contents

**Section 1 Introduction**

**Section 2 Communication Interface & Protocol Standard**

**Section 3 Database Fields & Database Record Format**

**Section 4 Order Processing Function & Information Message Flow**

**Section 5 Cross-auditing Between Administration Databases (ADs)**

**Section 6 AD Disaster Recovery & Backup**

**Section 7 Statistics**

**Annex 1 Normal MNP Porting Procedure**

**Annex 2 Procedures for Change of Gateway Number**

## 1. Introduction

### 1.1 Abstract

1.1.1 Apart from the real-time routing database (i.e. the GN database) adopted in Mobile Number Portability (MNP) as detailed in the HKCA 2103 "Requirement for Mobile Number Portability by Database Solution" issued by the CA, a decentralized Administration Database (AD) is required for the following objectives:

- to store the information to be exchanged among Network Operators;
- to maintain the data integrity of individual Network Operator's number porting records;
- to facilitate regular updating and auditing;
- to resolve any data discrepancies among Network Operators; and
- to serve as a backup image for disaster recovery.

1.1.2 This functional specification sets out the detailed requirements for implementing the decentralized AD by Network Operators to support MNP. There are communication links between AD systems of Network Operators for exchanging information related to MNP provision. The information exchanged among Network Operators is conveyed by the documents such as Number Porting Request (NPR), Advice of Portable Number (APN) etc. which are standardized in this Functional Specification.

1.1.3 In implementing MNP, a Network Operator can, with mutual agreement of an MNP Provider, make use of the number translation facility of the MNP Provider for Gateway Number (GN) translation and/or routing of call to the Recipient Network. The Network Operator can implement the AD by itself or use the AD operated by another Network Operator. The Network Operator which operates an AD for more than one Network Operator can have different options for implementing the AD for MNP, including:

- to partition its AD for MNP to support more than one Network Operator; or
- to build up dedicated AD for individual Network Operator.

### 1.2 Definitions

The following definitions shall be applied in this document:

**Administration Database (AD):** The off-line database that mainly performs the backup and auditing role for all ported-out and ported-in numbers, and is required to store working and history records of ported-out and ported-in numbers and their corresponding information of all mobile network operators and Mobile Virtual Network Operators (MVNO).

**AD Maintenance Agent (MA):** The AD Maintenance Agent is the Network Operator designated to be responsible for the agreed operation, administration and maintenance work of the physical AD server.

<b>Directory Number (DN):</b>	The telephone number that is dialled by a calling party to reach the called party. If the called party is a mobile customer which has been ported from the Donor Network to the Recipient Network, this is the same as the Ported Number.
<b>Donor Network Operator (DNO):</b>	Operator of the Mobile Network from which the number is being or has been ported.
<b>Donor Network:</b>	The Network of the DNO.
<b>DNO MA:</b>	The MA of the DNO.
<b>GN Database:</b>	The database that provides translation of the ported number into the gateway number (GN).
<b>MNP Provider:</b>	The Network Operator which provides number portability translation service to the Originating Network for the purpose of routing of calls to the Recipient Network. A MNP Provider may also play the role of a transit network if requested by the originating network.
<b>Network Operator:</b>	A licensee for the provision of fixed or mobile services (including holders of Fixed Carrier Licence, Mobile Carrier Licence, Unified Carrier Licence (with provision of fixed or mobile service authorised), and Services-Based Operator (SBO) Licence providing Class 1 or mobile virtual network operator services.
<b>Original DNO:</b>	Operator of the Mobile Network from which the number was first ported.
<b>Originating Network:</b>	The Mobile or Fixed Network from which a call is originated.
<b>Other MA:</b>	The MA who is neither representing RNO nor DNO for the porting request.
<b>Ported Number:</b>	Mobile number of a customer which has been ported from the Donor Network to the Recipient Network.
<b>Receiving Network Operator:</b>	The network operator that retrieves information exchange files from the sending network operators.
<b>Recipient Network Operator (RNO):</b>	Operator of the Mobile Network which has gained the ported number.

<b>Recipient Network:</b>	Network of the RNO.
<b>RNO MA:</b>	The MA of the RNO.
<b>Sending Network Operator:</b>	The network operator that sends information exchange files to other network operators.
<b>Terminating Network:</b>	The mobile network to which the called number is connected. By inference, this is the same as the Recipient Network.
<b>Transit Network:</b>	The network which is involved in carrying a call between the Originating Network and the Terminating Network but which is neither the Originating nor the Terminating Network.

### 1.3 Reference

- [1] HKCA 2103 "Requirements on Mobile Number Portability by Database Solution" issued by the CA.
- [2] "Exceptional Cases for Mobile Number Portability Provision" issued by the CA.
- [3] "Assignment of Two-Byte Network Identification Code".

## 2. Communication Interface and Protocol Standard

### 2.1 Objective

To establish a common communication interface and protocol standard on a reliable, high performance and resilient network between Network Operators for the support of the activities in MNP AD.

### 2.2 Network Topology

The backbone network chosen is a Frame Relay network. The conceptual network topology is shown in Figure 2-1.

Figure 2-1 Inter-AD Communication Network Configuration

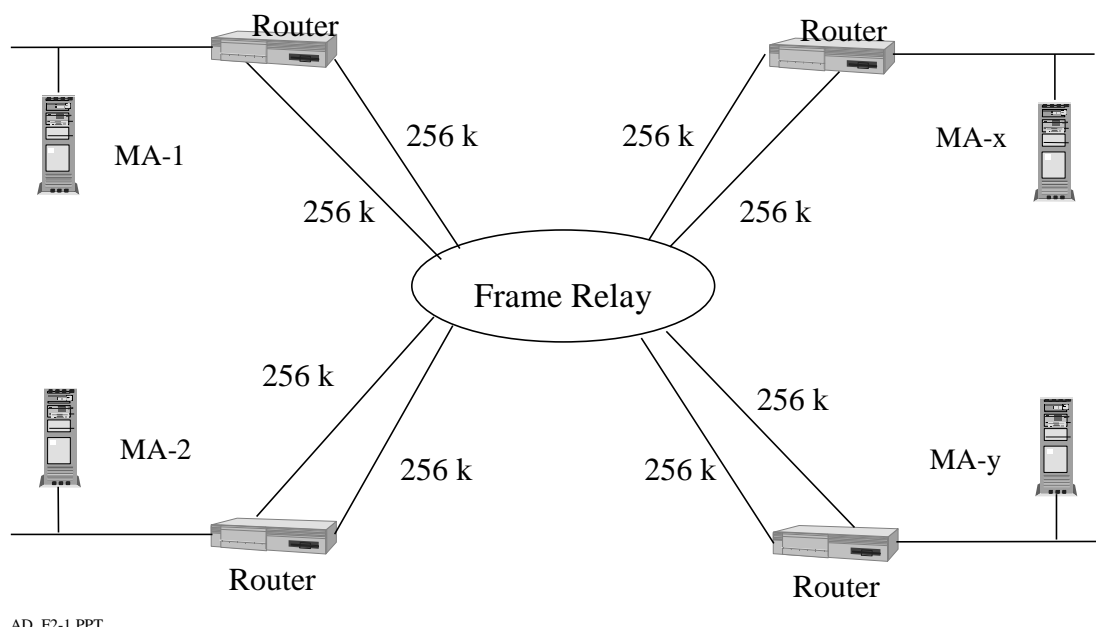

2.2.1 Each AD server is physically connected to a Frame Relay network by at least one router with two 256 kbit/s links which work in load-sharing manner. The logical connection between ADs should be by Permanent Virtual Circuit (PVC).

2.2.2 The AD servers should also be File Transfer Protocol (FTP) servers for pre-defined clients (fixed operators and other mobile network operators / MVNOs). Each AD server should support multiple concurrent FTP sessions.

2.2.3 The benefits of the configuration are summarized below:

- a) high availability and reliability
- b) easy to administer
- c) easy to expand
- d) secured network

## **2.3 Information Exchange**

- 2.3.1 The Sending Network Operator writes the information exchange files on a specific directory on its AD server for retrieval by the Receiving Network Operator over the communication network.
- 2.3.2 The Receiving Network Operator uses File Transfer Protocol (FTP) to poll information exchange files from a specific directory of the AD server of the Sending Network Operator.
- 2.3.3 Secured user identity (ID) and password for FTP accessing the AD server should be used for further validation.
- 2.3.4 The Receiving Network Operator should be allowed to read only in the specific directory on the AD server of the Sending Network Operator (see also 2.6.2).

## **2.4 Network Operators' Responsibilities**

- 2.4.1 A Network Operator should set up and administer an AD including the server, LAN, routers and Frame Relay lines, and be responsible for the maintenance, operation and security of the AD. In case of sharing of an AD by more than one Network Operator, one Network Operator has to be nominated as the Maintenance Agent (MA) to take up the above responsibilities. If a Network Operator runs its own AD, it will be the Maintenance Agent of itself.
- 2.4.2 In particular, mobile network operators / MVNOs should be responsible for the following:
- NPR negotiation
  - Initiate APN in provisioning phase
  - Reply on Audit
  - Audit dispute resolution

## **2.5 AD Maintenance Agent (MA) 's Responsibilities**

- 2.5.1 The responsibilities of MA should include the following :
- Operation & maintenance of AD
  - Fault reporting and handling of AD system
  - Audit File generation and comparison
  - Acknowledge receiving of APN in provisioning phase
  - Pass relevant data to the associated MNP Provider to update GN database before cutover window
  - Update its AD according to SCAPN received
  - Statistics generation
- 2.5.2 The router used for connection by the AD server to the communication network should be compatible with the routers used by other MAs.



- 2.5.3 Internet Protocol (IP) addresses and mask of their own AD servers and routers, Frame Relay Data Link Connection Identifier (DLCI) of the PVCs, user ID and password of the AD servers should be given to all other MAs and kept confidentially.
- 2.5.4 Each MA should process their own fault handling within their own operations. In case of joint investigation is required, the MAs should coordinate themselves.

## **2.6 Network Security**

- 2.6.1 User ID and password should be given to the staff on a need-to-know basis.
- 2.6.2 Each Sending Network Operator will assign a specific working directory in its AD server for information to be retrieved by each Receiving Network Operator. On retrieval of information from the other AD servers, the MA should only read the directories assigned to itself or its client Network Operators.

## **2.7 System Reliability**

- 2.7.1 Redundancy should be built in the AD system components, including the AD server and router equipment, to ensure high reliability of operation.
- 2.7.2 Detailed procedures and requirements to address system faults/failures and reliability issues should be referred to the Exceptional Cases for MNP Provisioning and Section 6.3 in this document.

## **2.8 Clock Synchronization**

- 2.8.1 MAs should align AD system clock with the master clock of the Hong Kong Observatory on a regular basis to ensure clock synchronization amongst AD systems.

### 3. Database Fields and Database Record Format

#### 3.1 Objectives of establishing a decentralized AD

- To maintain data integrity between the administrative/operational database of individual Network Operator for implementing number portability through periodic updating and auditing.
- To act as backup reference for disaster recovery in case of breakdown of the administrative/operational database of any Network Operator.

#### 3.2 Database Content & Database Format

Regarding the objective of the AD, it mainly performs the Backup and Auditing role for all ported numbers. Therefore the database is required to store all mobile network operators' / MVNOs' working and history records of ported numbers and its corresponding information only.

Regarding the content of the database, if the Changeover Date is greater than zero and the Termination Date is equal to zero (Note 1), the current status of the record is working. On the other hand, if the Termination Date is greater than zero, the record is a history record and it should be retained at least 6 months for reference purpose.

The record will be created or updated after the changeover is successfully implemented. The following are possible scenarios:

- . Normal Porting - A new working record will be created and all corresponding information will be based on the APN.
- . Successive Porting - The working record will be terminated by updating the termination date and then create a new working record for the new porting.
- . Relinquishment of Number - The working record will be terminated by updating the termination date.
- . Porting Back to Original DNO - The working record will be terminated by updating the termination date.

<b>Common Database Content:</b>
---------------------------------

- Directory Number [✂ ]
- Gateway Number [✂ ]
- RNO (Recipient Network Operator) [✂ ] Note 4
- DNO (Donor Network Operator) [✂ ] Note 4
- Original DNO [✂ ] Note 4
- Original Type of Service [✂ ]
- Existing Type of Service [✂ ]
- Changeover Date [✂ ]
- Termination Date [✂ ]
- RNO/DNO Reference Serial No. [✂ ]

Note 1 [✂ ]

Note 2 for DN format [✂ ]

Note 3 for GN format [✂ ]

Note 4  
See Reference 3

Note 5 [✂ ]

Note 6 [✂ ]

## 4. Order Processing Function & Information Message Flow

### 4.1 Introduction

When there is a request for number porting service, the communications network between ADs is used for information exchange between Network Operators for the MNP order. The information received by a Network Operator can be used to update its AD automatically.

### 4.2 Information Exchange

The information exchange between Network Operators includes the following documents.

- i) NPR (Number Portability Request)
- ii) NTNPR (Negotiation of NPR)
- iii) AKNPR (Acknowledgment to NPR)
- iv) CLNPR (Cancellation of NPR)
- v) ACNPR (Acknowledgment to CLNPR)
- vi) APN (Advice of Porting Number)
- vii) AKAPN (Acknowledgment to APN)
- viii) CLAPN (Cancellation of APN)
- ix) ACAPN (Acknowledgment to CLAPN)
- x) SCAPN (Successful Completion of APN)
- xi) ARPN (Advice of Relinquished Porting Number)

#### Negotiation Phase

IED	Description	Sender Address	Receiver Address
NPR	Number Portability Request	RNO	DNO
CLNPR	Cancellation of NPR	RNO	DNO
AKNPR	Acknowledgment to NPR	DNO	RNO
ACNPR	Acknowledgment to CLNPR	DNO	RNO
NTNPR	Negotiation of NPR	DNO	RNO

#### Provisioning and Completion Phase

IED	Description	Sender Address	Receiver Address
APN	Advice of Porting Number	RNO	All MAs
SCAPN	Successful Completion of APN	RNO	All MAs
CLAPN	Cancellation of APN	RNO/ MA	All MAs/RNO
AKAPN	Acknowledgment to APN	All MAs	RNO
ACAPN	Acknowledgment to CLAPN	All MA	RNO

#### Termination Phase

IED	Description	Sender Address	Receiver Address
ARPN	Advice of Relinquished Ported No.	RNO	Original DNO, All MAs

### 4.3 Information Exchange Files

#### 4.3.1 File Name

MNP documents are contained in files which are sent to the relevant network operators and MAs. In order to recognize the received files, the following naming convention for information exchange files is adopted.

1st - 2nd byte: Sending Network Operator  
(See Reference 3)

3rd - 4th byte: Receiving Network Operator  
(See Reference 3)

5th - 8th byte: File Serial Number (start from 0001)

file extension: INM for information exchange files

For instance, OHOB0002.INM is the second information exchange file sent from Operator H to Operator B (assuming that the two-byte network codes of Operators B and H are "OB" and "OH" respectively).

#### 4.3.2 File Format

An information exchange file contains multiple MNP documents (see Section 4.2). The file format is as follows.

Header	Doc #1	.....	Doc #n	EOF
--------	--------	-------	--------	-----

#### 4.3.3 Document Contents

Each MNP document consists of the following fields. All fields are mandatory except the field "comments", i.e. it is included when required.

Document Field	Content
Type of document	[  ]
Directory number (DN)	
Gateway number (GN)	
Recipient network operator (RNO)	
Donor network operator (DNO)	
Original DNO	
Original Type of service	
Existing type of service	
Changeover start date	
Changeover start time	
Changeover end time	
RNO/DNO reference serial number	
Number of documents in a	

RNO/DNO reference serial number	
Name	
ID Number / Passport Number	
Comments	

Note: Field delimiter = [⌘ ]  
 End of document = [⌘ ]

The format for a document is shown as follows:

[⌘ ]							
------	--	--	--	--	--	--	--

If the "Comments" field is absent, the document should have a “[⌘ ]” before the [⌘ ].

#### 4.3.4 Header Contents

Each information exchange file contains a header with the following fields.

Header Field	Content
File type	[⌘ ]
Creation date	
Sending Network Operator	
Receiving Network Operator	
Total number of documents transferred	

Note: Field delimiter = [⌘ ]  
 End of header = [⌘ ]

The format for the header is shown as follows:

[⌘ ]							
------	--	--	--	--	--	--	--

#### 4.4 Read/Write Process for Information Exchange Files

4.4.1 Information exchange files should be retrieved based on 30 minutes polling interval. The reading cycles would start at HH:00 and HH:30. To allow the Receiving Network Operator to retrieve the information in a reading cycle, the Sending Network Operator should complete the writing operation for those information 15 minutes before the start of the corresponding reading cycle. The MAs should arrange to match the clock of its AD with the time of the Hong Kong Observatory as stipulated in section 2.8.1.

4.4.2 During a write cycle, the Sending Network Operator should write the document files on to its directory for a Receiving Network Operator. The Sending Network Operator should write document files in sequence together with a control file for that Receiving Network Operator. While a document file or a control file is being updated or created, reading of the file by the Receiving Network Operator should be blocked or disabled so that no partial or incomplete file will be received by the Receiving Network Operator.

4.4.3 The control file should be a text file in ASCII codes (the same as other document files) with the format specified as follows:

- One single control file per directory for all files (document file, audit file, rectification file, disaster recovery file etc.) to be read by the Receiving Network Operator
- Name of control file should be "[X ]"
- Maximum number of entries per control file should be [X ]
- The control file contains entries with the following layout except for audit files :

[X ]

- The control file contains audit file ([X ]) entries has the following layout :

[X ]

Where

- '[X ]' is the name of the document file to be received by the concerned network operators/MAs. The format of this file name should be exactly the same as defined in sections 4.3.1, 5.2.11 and 6.2.1;

- '[X ]' is the extension of compressed files by gzip;

- '[X ]' is the date on which the file created;

- '[X ]' is the hour and minute at which the file created; and

- the field delimiter is the character "[X ]" and [X ] is to be found at the end of each line in the file.

Below is an example content and layout of the control file:

[X ]

Below is an example of the control file containing audit files:

[X ]

4.4.4 An example for the possible implementation of the read/write operation between AD servers is given in Figure 4-1.

Figure 4-1 Example of Possible Implementation of Read / Write Operation between AD servers

[X ]

## 4.5 Information Exchange Procedures

- 4.5.1 The detailed procedure for Normal MNP Porting should be referred to [Annex 1](#).
- 4.5.2 The detailed procedure regarding cancellation of orders and other exceptional cases should be referred to the Exceptional Cases for MNP Provision.

## 4.6 Change of Gateway Number Request by Recipient Network Operator

It has been identified that there may be a need for the Recipient Network Operator (RNO) to request the change of Gateway Number (GN) for one or more customers. This request for change of GN is implemented in a similar manner to the MNP service request except that the Donor Network Operator (DNO) and the RNO are the same Network Operator.

### 4.6.1 Notification Procedure for Change of Gateway Number Request

The procedure for change of GN request is based on the number porting service request and activation process (without the NPR and AKNPR) and no new document types are required. Details should be referred to [Annex 2](#).

The procedure for change of GN request is summarised as follows:-

- a) The RNO (which is also the DNO) sends an APN to all MAs according to normal porting procedures. The RNO and DNO fields contain the same Network Operator code.
- b) On receipt of the APN, all MAs will reply to the RNO with an AKAPN.
- c) For cancellation of APN, the details should refer to the Exceptional Cases for MNP Provision.
- d) If the cutover is successful, the RNO shall send a SCAPN to all MAs to indicate the successful completion of the process of receiving the necessary protocols.



## 5. Cross-Auditing Between ADs

### 5.1 Objective

In order to eliminate data discrepancies, a cross-reference mechanism has to be set up for auditing between the ADs managed by individual MAs. The MA of each Network Operator will be responsible for the operation to ensure data integrity of the system.

### 5.2. Cross Auditing

<b>Database Exchange</b>
--------------------------

- 5.2.1 During the first week of each month, individual MA will sort its AD by RNO into different output audit files and then send the files to the corresponding RNO through communication interface for auditing. The audit files shall be compressed by [X] with file extension as "[X]". The audit file should contain:
- The header record for comparison purpose.
  - All Ported Numbers (including working and last month historical record) for the RNO under the AD records up to the end of last month (23:59)
- 5.2.2 The DN plus the RNO/DNO Reference Serial Number shall be used as the key to uniquely identify a record in the AD.

5.2.3 The following is the example of the database exchange that is initiated by MA A at 1 November 2013 (assuming that the two-byte network codes of MA A, Operators D, F and H are “AA”, “OD”, “OF” and “OH” respectively):

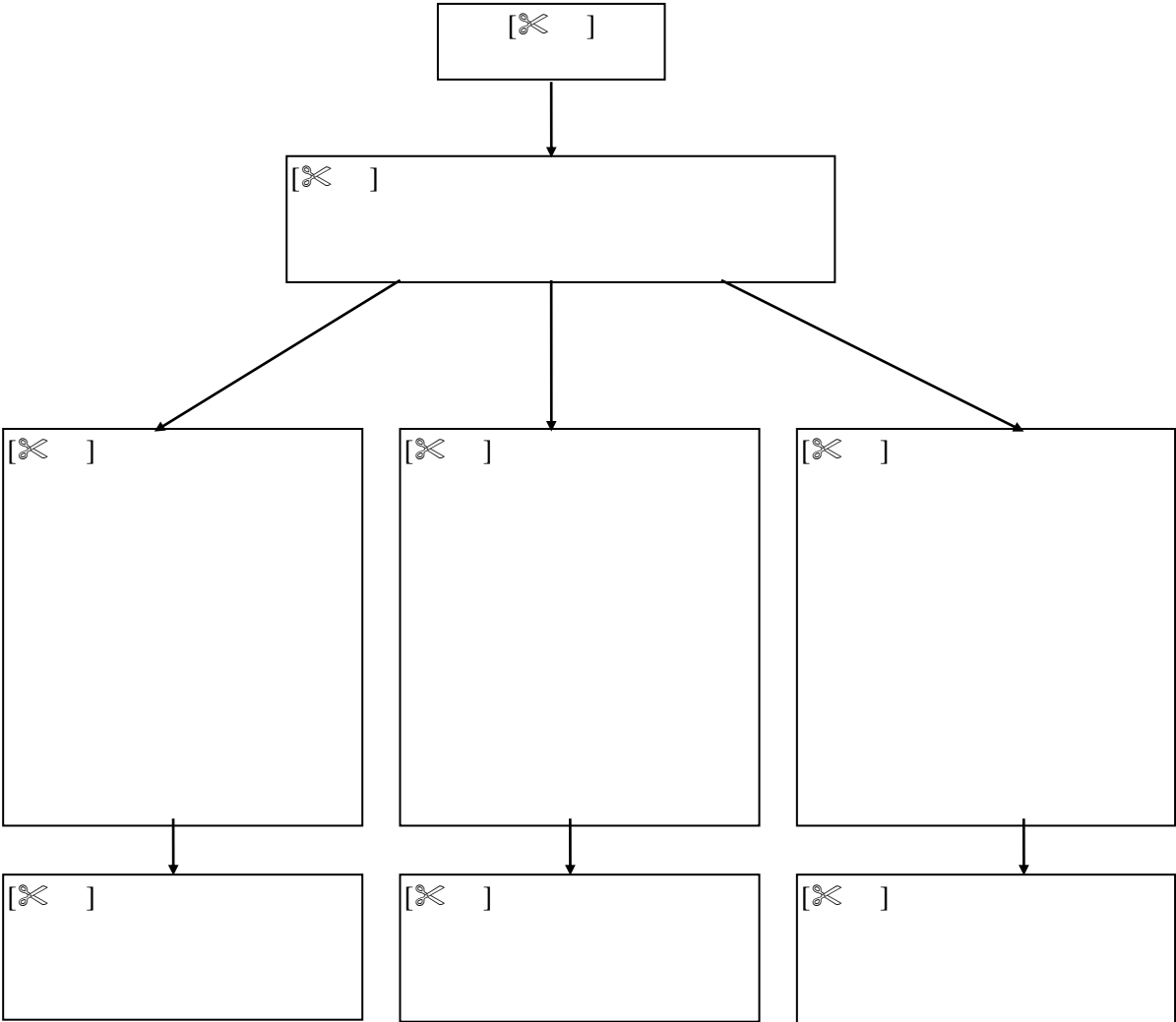

**Cross Auditing & Rectification**

5.2.4 Each Receiving Network Operator (i.e. the RNO), after receiving files sent to it from the sending MAs, will compare all the files to its own AD. The Network Operator may delegate the file comparison to its own MA. In case discrepancies arise, the RNO should take responsibility to investigate and rectify the mismatch records and then send back the corrected files to the sending MAs for updating their ADs. RNO or its MA should respond to audit file with a rectification file within 7 days upon request by other MAs. The rectification file should contain all corrected/amended entries and the corresponding header record. On the other hand, if no mismatch record exists, the RNO has to send back the rectification file with the header record having mismatch counter of zero for notification purpose. The RNO, sending the rectification file, should confirm with the receiving MAs that the mismatched records are updated to its AD two days after the rectification file was sent out. If necessary, the "Request for MNP Fault Investigation /Modification" Form should be sent to the receiving MAs as a confirmation of the request to modify the AD. If dispute arises, the dispute resolution procedures outlined in section 5.3 shall be followed.

**Successful Comparison**

5.2.5 The following is the example of the general flow for file rectification action by Operator B which is the RNO, upon reception of audit files from MAs B, C and D. The result is successful comparison (all record matched) for the file as at 1 November 2013 (assuming that the two-byte network codes of MAs B, C, D and Operator B are "AB", "AC", "AD" and "OB" respectively):

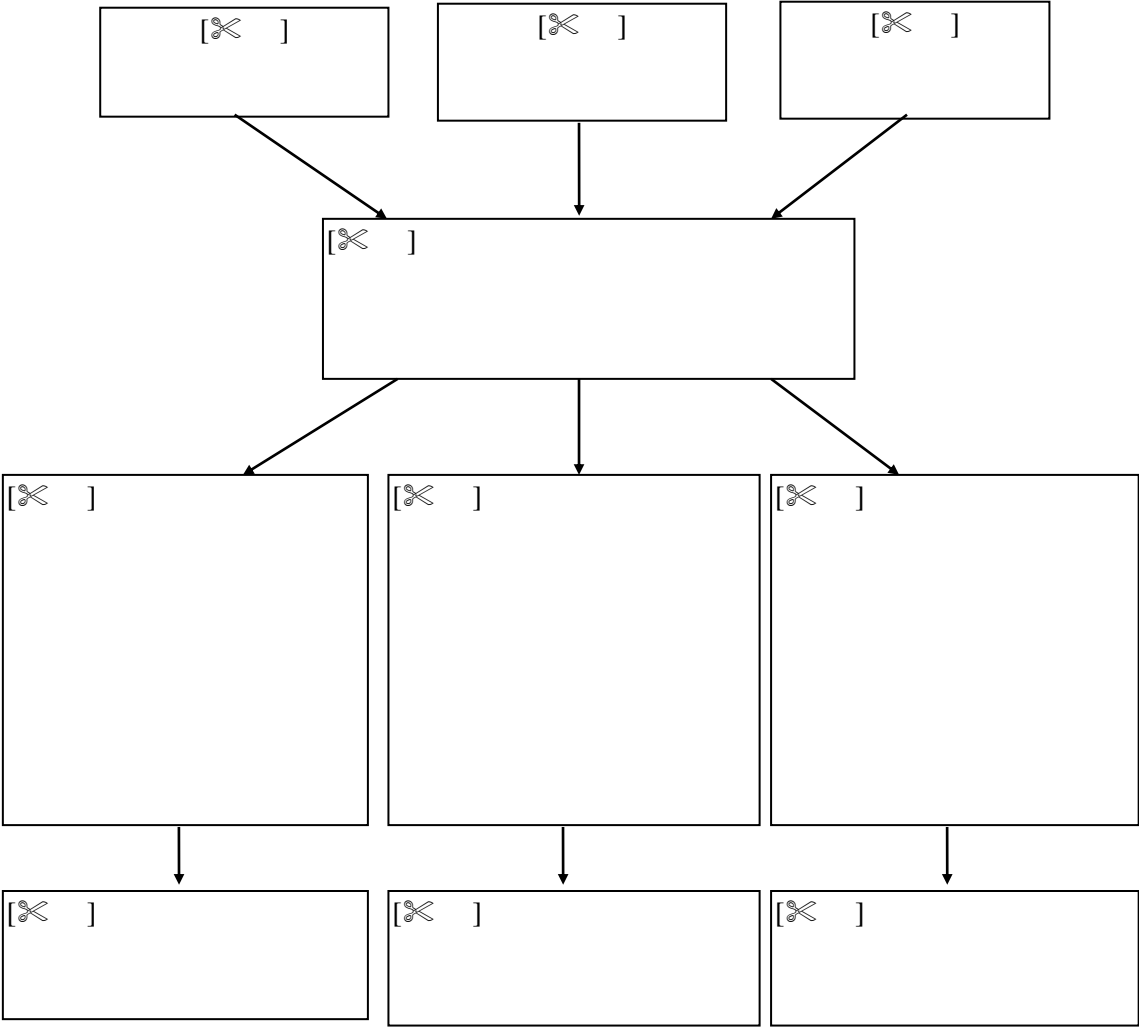

**Unsuccessful Comparison**

- **Header total & total # of record transferred mismatch**

5.2.6 In case the total transferred count on the header record is mismatched with records transferred, the RNO has to send a 'Verification' type file in order to get the file again through the communication linkage for cross auditing.

5.2.7 The following is the example of the general flow for the file rectification action by Operator B which is the RNO as at 1 November 2013 with unsuccessful comparison due to header total & total # of record transferred mismatch. The file is required to be transferred again in order to perform the comparison:

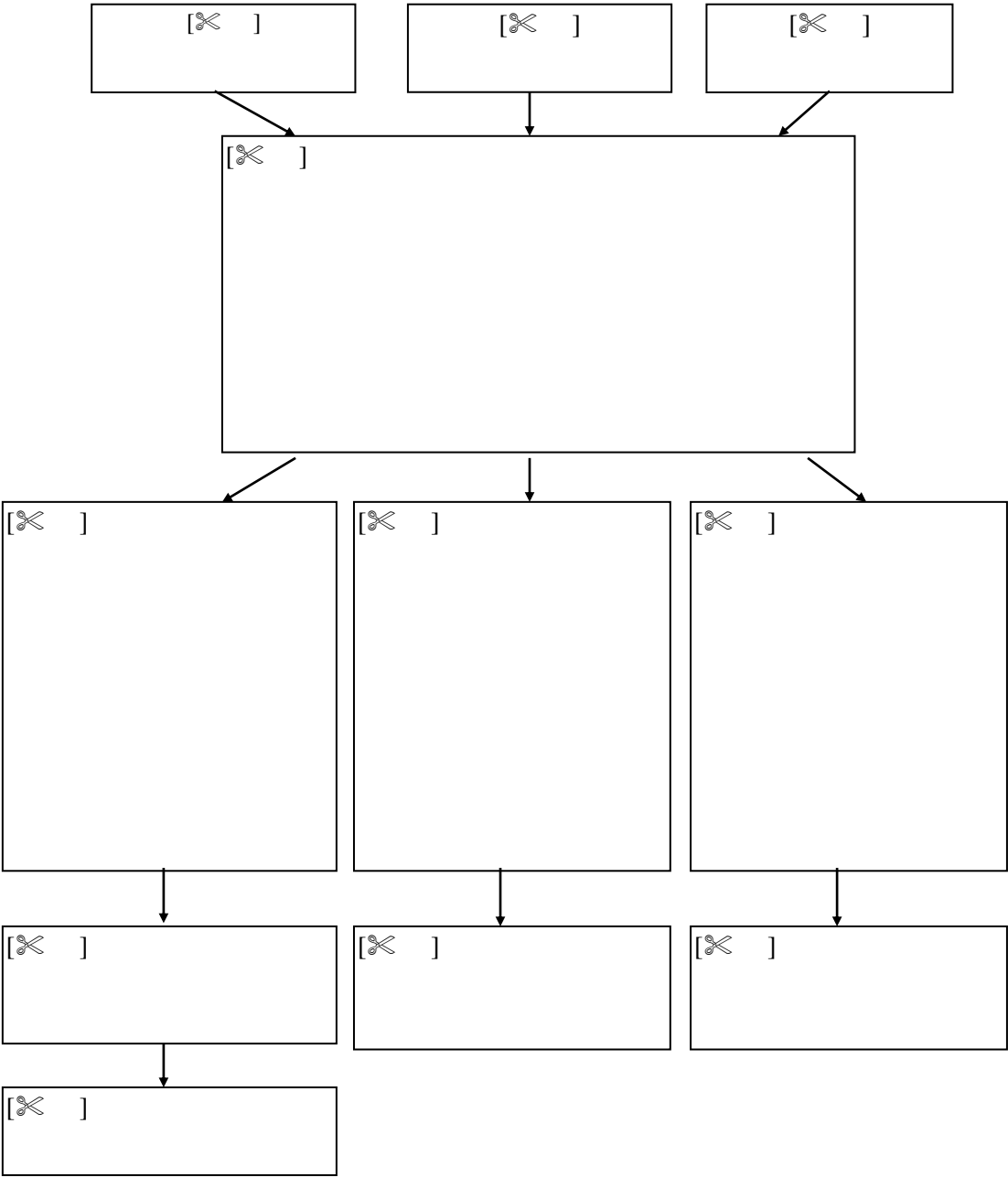

- **AD information mismatch with audit files**

5.2.8 In case information mismatch arises between records indexed by the key, the RNO should take full responsibility to investigate and rectify the mismatch records and then send the corrected files to the sending MAs for updating their ADs. The following is the possible scenarios of information mismatch between the received audit files and the RNO's AD:

- ⇒ Record not found in the RNO's AD: the record is required to be deleted from the sending MA's AD (Action : **D**delete).
- ⇒ Record exists in the RNO's AD but missing in the received audit file: the record is required to be added in the sending MA's AD (Action : **A**dd)
- ⇒ Information mismatch between records indexed by the same key: the record is required to be updated in the sending MA's AD (Action : **U**ppdate)

5.2.9 The following is the example of the general flow for file rectification action by Operator B which is the RNO as at 01/11/2013 with unsuccessful comparison due to the file content & database mismatch.

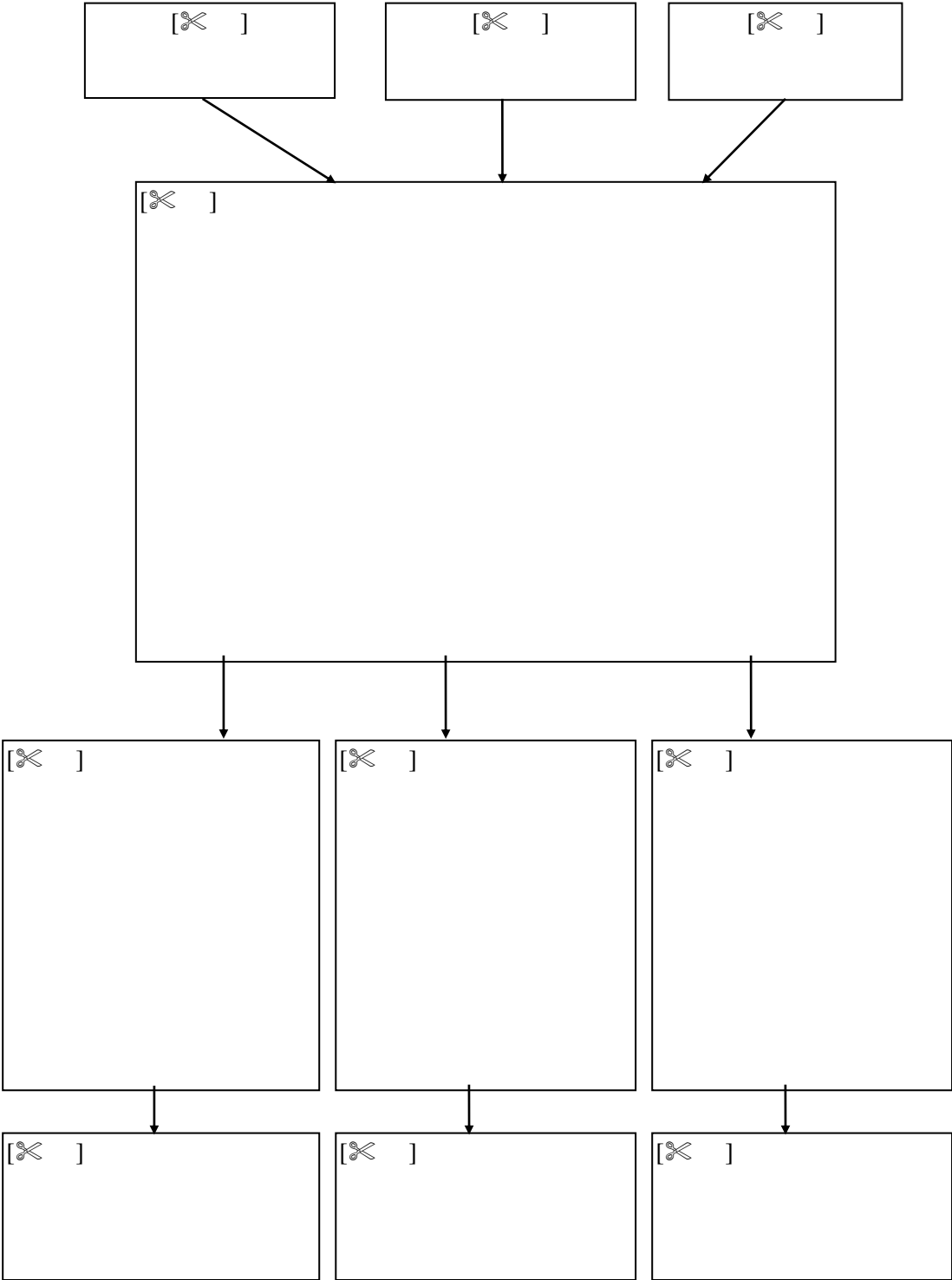

5.2.10 Each rectification file may contain a mix of detail records with "[Redacted]", or "[Redacted]" or "[Redacted]".

**File Name**

5.2.11 In order to recognize the received files for auditing purpose, the following naming convention for audit and rectification files is adopted:

[X ]

**Header Record**

File Type: [X ]

Verification Date: [X ]

Sending Network Operator: [X ]

Receiving Network Operator: [X ]

Total # of Record Transferred: [X ]

**Detail Records for Rectification**

- Directory Number [X ]
  - Gateway Number [X ]
  - RNO (Recipient Network Operator) [X ]
  - DNO (Donor Network Operator) [X ]
  - Original DNO [X ]
  - Original Type of Service [X ]
  - Existing Type of Service [X ]
  - Changeover Date [X ]
  - Termination Date [X ]
  - RNO/DNO Reference Serial No. [X ]
  - Action Code [X ]
- [X ]

Note : Please refer to Section 3.2 for the detailed description of fields.

**Field Delimiter**

The Delimiter chosen is the [X ].

**Record Separator**

The Separator chosen is the [X ].

**File Format**

[X ]				
------	--	--	--	--

**5.3 Dispute Resolution**

In case mismatch record arises, the RNO should take full responsibility to investigate and rectify the mismatch record and then inform the sending MAs for updating their ADs. If more than one operators claimed to be the RNO, then the actual RNO (the mobile network operator / MVNO with which the working mobile number is connected) should then be identified among the concerned RNOs. The actual RNO should then clarify the situation, arrange to rectify the mismatch record, and then keep all the MAs and the concerned Network Operators informed of the findings.



## 6. AD Disaster Recovery & Backup

### 6.1 Introduction

The objective of AD disaster recovery & backup procedure described in this section is to handle breakdown of the ADs (including working and back-up systems) of any individual MA.

In case of disaster, a request can be made by an MA to one of the other MAs for:

- a) sending full information of all working records
- b) sending full information of all working and the last six-month history records (i.e. a database image).

(Note: A working record contains a ported number which is working in a RNO)

### 6.2 Information for Database Recovery

#### 6.2.1 File Name

In order to recognize the received files, the following naming convention is used for the disaster recovery files.

[✂ ]

For instance, [✂ ] is the database image file sent from MA B to MA A on 29 May (assuming that the two-byte network codes of MAs A and B are “AA” and “AB” respectively).

#### 6.2.2 File Format

The files contain multiple records and the format for these files is as follows:

[✂ ]				
------	--	--	--	--

#### 6.2.3 File Contents

This file contains the information of all working records and history records for the last six months. Each file contains a series of records and each record contains the following fields.

Record Field	Content
Directory number (DN)	[✂ ]
Gateway number (GN)	
Recipient network operator (RNO)	
Donor network operator (DNO)	
Original DNO	
Original type of service	

Existing type of service	
Changeover start date	
Termination date	
RNO/DNO reference serial number	

Note: Field delimiter = [⌘ ]  
 End of record = [⌘ ]

The format for the record is shown as follows:

[⌘ ]							
------	--	--	--	--	--	--	--

### 6.2.4 Header Content

The file contains a header with the following fields.

Header Field	Content
File type	[⌘ ]
Creation date	
Sending Network Operator	
Receiving Network Operator	
Total number of records transferred	

Note 1: Field delimiter = [⌘ ]  
 End of header = [⌘ ]

Note 2: Multiple files for disaster recovery file sending will be further studied.

The format for the header is shown as follows:

[⌘ ]							
------	--	--	--	--	--	--	--

### 6.3 Database Recovery Procedures

- a) In case of breakdown of its AD, the MA facing disaster should contact one of the other MAs by phone requesting for the file, and supplement by a formal letter later.
- b) The MA being contacted should send out the required information (see Section 6.2 for information details) within one working day.
- c) The MA facing disaster should make sure the AD system is back to normal before any cross-auditing function can be performed.
- d) In case of failure of the GN databases, the Network Operators and MNP Providers should proceed with disaster recovery by arranging with their associated MAs if necessary.

## 7. Statistics

### 7.1 Introduction

A number of statistical reports should be generated by the AD system for reporting by the Network Operator to OFCA on both periodical and on-demand basis to serve the following purposes:-

- satisfy OFCA's requirement of statistics submission and to facilitate application of additional mobile numbers ;
- monitor the efficiency and effectiveness of number porting activities;
- provide information for capacity planning; and
- provide information to support related operational requirements e.g. charging, billing, etc.

### 7.2 Statistics Reports

#### 7.2.1 Periodic Statistics Report to OFCA

Mobile number porting statistics in the format as shown in Attachment 7-1 should be produced on a monthly basis for submission to OFCA. Each mobile network operator / MVNO should submit the statistical report on a per mobile network basis.

#### 7.2.2 On-demand Statistics Reports to OFCA

The system should be able to produce the porting history, at least in the past six months, of a particular mobile number on demand.

### 7.3 Examples on Number Porting Statistics

7.3.1 For the purpose of statistics reporting, the Network Operator submitting the report should list out porting in/out cases against those numbers originally assigned to its network. For reporting of porting-in numbers, the reporting Network Operator is the working RNO and the breakdown should be against other Network Operators as the Original DNOs. For reporting of porting-out numbers, the reporting Network Operator is the Original DNO and the breakdown should be against other Network Operators as the working RNOs. The examples in 7.3.2 to 7.3.4 illustrate the detailed requirements.

#### Normal Ported-Out and Ported-In Case

7.3.2 Assuming that the mobile number porting starts in Month N in 2013 and the number of "Ported-In" and "Ported-Out" mobile numbers are the same in Month N and Month N+1 in 2013, the "Mobile Number Portability Statistics for OFCA" for Month N+1 in 2013 submitted by Operator A for their GSM1800 (PCS) network should be as shown in Table 7-1.

**Mobile Number Portability Statistics for OFCA**

Mobile network operator : Operator A

Mobile Network : GSM1800 (PCS)

Month : Month N+1, 2013

Mobile network operator	Network	Number of Mobile Numbers "Ported-In" during the current month	Net Total Number of Working "Ported-In" Mobile Numbers at the end of the current month	Number of Mobile Numbers "Ported-out" during the current month	Net Total Number of "Ported-out" Mobile Numbers at the end of the current month
Operator B	GSM900	100	200	100	200
Operator C	GSM1800	100	200	100	200
Operator E	GSM900	100	200	100	200
Operator F	3G	100	200	100	200
Operator G	GSM1800	100	200	100	200
Operator H	GSM900	100	200	100	200
Operator I	GSM1800	100	200	100	200
Grand Total :		700	1,400	700	1,400

**Table 7-1**

### Relinquishment of Ported Numbers and Porting-back

7.3.3 An example is given in Table 7-2 which assumes 100 mobile numbers in Operator B's network were ported to Operator F's network in Month N in 2013, and 20 of these numbers were returned to Operator B in Month N+1 in 2013 due to relinquishment of ported numbers (the termination of the services by some customers) or due to porting-back. Suppose there were no more porting events among these two mobile networks in Month N+1 in 2013, the porting statistics in Month N and Month N+1 in 2013 in Operators B and F should be as shown in Table 7-2.

	Operator B	Operator F
Month N, 2013	Net Ported-out mobile numbers = 100 (to Operator F)	Net Ported-In mobile numbers = 100 (from Operator B)
Month N+1, 2013	Net Ported-out mobile numbers = 80 (to Operator F)	Net Ported-In mobile numbers = 80 (from Operator B)

**Table 7-2**

### Successive Porting Case

7.3.4 An example is given in Table 7-3 which assumes 100 mobile numbers in Operator E's network (original donor network) were ported to Operator C's network in Month N in 2013. In Month N+1 in 2013, 20 out of 100 mobile numbers were further ported to Operator A's network. Suppose there were no more porting events among these three networks in Month N+1 in 2013, the porting statistics in Month N and Month N+1 in 2013 in Operators E, C and A should be as shown in Table 7-3.

	Operator E	Operator C	Operator A
Month N, 2013	Net Ported-Out mobile numbers = 100 (to Operator C)	Net Ported-In mobile numbers = 100 (from Operator E)	-
Month N+1, 2013	Net Ported-Out mobile numbers = 100 (80 to Operator C and 20 to Operator A)	Net Ported-In mobile numbers = 80 (from Operator E)	Net Ported-In mobile numbers = 20 (from Operator E)

**Table 7-3**

**Mobile Number Portability Statistics for OFCA**

Mobile network operator / MVNO :

Mobile Network :

Month :

Mobile network operator / MVNO	Network	Number of Mobile Numbers "Ported-In" during the current month (Note 1)	Net Total Number of "Ported-In" Mobile Numbers at the end of the current month (Note 1)	Number of Mobile Numbers "Ported-out" during the current month (Note 2)	Net Total Number of "Ported-out" Mobile Numbers at the end of the current month (Note 2)
Grand Total :					

Note 1 : Total number of mobile numbers ported in from other networks acting as the Original DNOs.

Note 2 : Total number of mobile numbers ported out to other networks from the originally allocated number blocks of the operator submitting this report and which remain in the other networks acting as the working RNOs.

# **ANNEX 1**

## **Normal MNP Porting Procedure**

## 1. Normal MNP Porting Process

### General

- 1.1 Each Network Operator (NO) will be responsible for number portability internal to their own network and which does not affect other Network Operators. This document describes the inter-operator MNP procedures that require joint or coordinated activities. To achieve MNP, each Network Operator should nominate one or more MNP Provider and MA, which could be the Network Operator itself, to provide GN database look-up and other logistic services. For the sake of clarity, the procedures described in this Annex indicate the actual party (NO, MA, MNP Provider) that should carry out the specific activities for the Network Operator. The HKCA 2103 - Requirements for Mobile Number Portability by Database Solution should be referred to for the allocation of responsibility for these procedures, which in all cases lie with the relevant Network Operator.

The internal procedures and agreement between a Network Operator and its MNP Provider(s) and MA(s) are outside the scope of this document.

The Normal MNP Porting Procedure is illustrated in Figures 1A, 1B, 2 and 3 (assuming that the two-byte network codes of Operators B and E are “OB” and “OE” respectively).

### Negotiation Phase

- 1.2 The customer requests number porting service from the Recipient Network Operator (RNO). This will involve the completion of the Mobile Number Portability Application form for subsequent entry to the internal provisioning process.
- 1.3 Upon receiving the customer service request, the RNO performs initial checks to confirm the number portability can be applied. If initial checks are passed, the RNO will send a Number Portability Request (NPR) with proposed cutover date/time to the DNO at least 24 working hours in advance of the proposed cutover date and time (see paragraph 1.7). The DNO field in the NPR should be automatically generated by checking the working record of the AD system and the advice of mobile number allocation issued by OFCA to determine if the number is a fresh porting or a second porting.

The first batch of NPR is to be written to the AD system at 09:00 hour. If RNO tried to write the record at 08:45 hour, the DNO could reject the NPR. On receipt of the NPR from the RNO, the DNO performs initial checks and carries out necessary steps to facilitate the porting of the number concerned. If initial checks are passed, the DNO will reply the RNO by sending an Acknowledgment to NPR (AKNPR) to the RNO. For NPR received by the DNO from the RNO in the morning session (09:00-12:00), the DNO should reply before 16:00 in the same day. For NPR received by the DNO from the RNO in the afternoon session (12:00-18:00), the DNO should reply before 16:00 in the next day.

If problems are found in the initial checks, the DNO will send a Negotiation of NPR (NTNPR) to the RNO to advise of the problem(s) and, if appropriate, any suggestion(s) to resolve the problem(s). On receipt of the NTNPR, depending on the nature of the problem(s), the RNO will either further negotiate and issue revised NPR(s) to DNO or issue Cancellation of NPR (CLNPR) to DNO. The RNO must issue CLNPR to cancel the old



NPR and receive the ACNPR from DNO before sending the new NPR of the same DN. If a RNO issued a new NPR of same DN while the CLNPR of the old NPR was still outstanding, the DNO should detect it as a double porting and should reject with the rejection code "M" (see section 2.3.1 of the Exceptional Cases for MNP Provision issued by OFCA).

In case the negotiation phase is over (i.e. Day 1 18:00 for the morning session and Day 2 18:00 for the afternoon session), those outstanding NPRs (i.e. NPR cannot be proceed to the Provisioning Phase) issued in that corresponding session must be discarded automatically in the DNO AD System. Any mobile operator can issue new NPR for that particular Directory Number in next available session to the DNO, DNO should process the NPR as usual.

The last batch of the morning session NPR should be written to the AD on or before 11:45 hours. Similarly, for the afternoon session, operators should only attempt to write onto their AD systems by 17:45 hours.

### **Provisioning Phase**

- 1.4 On receipt of AKNPR from the DNO, the RNO will then send an Advice of Portable Number (APN) with the cutover details to all the MAs in advance of the agreed cutover date and time. The APN should be sent by the RNO before 17:30 of the same day for NPRs in the morning session and before 17:30 of the next day for NPRs in the afternoon session.

On receipt of the APN, all the MAs must check the DNO field in APN document against their own AD working record and the advice of mobile number allocation issued by OFCA before reply to the RNO with an Acknowledgment to APN (AKAPN) to confirm the receipt of the APN sent by the RNO. If the DNO field in APN document was wrong, the MA should reject the porting with the rejection code "[⌘ ]" (see section 2.6.6 of the Exceptional Cases for MNP Provision issued by OFCA). The Network Operators and their associated MAs and MNP Providers should proceed the cutover on the agreed cutover date and time. The AKAPN should be replied to the RNO before 19:00 of the same day for NPRs in the morning session and before 19:00 of the next day for NPRs in the afternoon session.

- 1.5 The pre-provisioning activities of the RNO must not interfere with the existing routing of calls to and from the porting-in mobile customer who is still using the Donor Network.
- 1.6 If any technical difficulties are encountered by either the RNO or the DNO or other network operators that would jeopardize the achievement of the agreed cut-over date/time, then the case should be handled according to the Exceptional Cases for MNP Provision.

### **Completion Phase**

- 1.7 For normal cases of MNP porting, the following process time should be complied by the network operators. For NPRs sent by RNO to DNO in the morning session (09:00-12:00) of Day 1, the whole process of porting should be completed by the mid-day cutover window (12:00-14:00) of Day 2. For NPR sent by RNO to DNO in the afternoon session (12:00-18:00) of Day 1, the whole process of porting should be completed by the mid-night cutover window (01:00-04:00) of Day 3. 01:00 hours and 12:00 hours is the AD working record updating time for mid-night cutover and afternoon cutover sessions respectively.

- 1.8 Before the prepared AD data is uploaded to GN system. MAs should check if there were CLAPN received and it is not necessary to check the accompanying ACAPN is received or not.
- 1.9 If the RNO does not identify any faults or receive any fault reports from other network operators by a specified period after the completion of the cutover window, then the RNO will consider the cutover as successful. The RNO will then send a Successful Completion of APN (SCAPN) to all MAs to indicate the successful completion of the process of receiving protocols. The SCAPN is not a signal given out by the RNO that the physical cutover was successful or not. All MAs should inform the RNO in the first instance either by phone or by fax in case of AD uploading to GN failure.

## **2 Cut-over Procedures**

- 2.1 Prior to the start of cutover, as described in Section 1, each Network Operator and its associated MA and MNP Provider will be responsible for having all deliverables ready for service.
- 2.2 The RNO will have completed all provisioning and pre-provisioning activities and all the Network Operators will have all the necessary number porting data in place prior to cutover.
- 2.3 Within the scheduled cutover time-window, the DNO will disconnect service for the customer and the RNO will commence service activation of the customer to its network. Within the same time window, the DNO, the RNO and all other Network Operators will effect a re-route on the routing plan of the ported number.
- 2.4 If the porting-in mobile customer is still busy within the time-window, the DNO may force-release the existing connection of this customer, without waiting for it to be idle, to carry out the cutover.
- 2.5 The physical cutover and the activation of routing plan are two independent activities and could be started and finished at any time within the agreed time-window.
- 2.6 The RNO is responsible for the successful completion of the cutover. If, for any reason, the cutover is unsuccessful, the case will be treated as a fault. The RNO will be responsible for resolving the fault, the DNO and other Network Operators will work closely with it to solve the problem. The RNO is also responsible for notifying the porting-in customer of the status.
- 2.7 If the RNO does not identify any faults or receive any fault reports from other Network Operators by a specified period (2 hours) after the completion of the cutover window, then the RNO will consider the cutover as successful. The RNO shall send a Successful Completion of APN (SCAPN) to all the MAs within the cutover window period to indicate the completion of the process of receiving all necessary protocols. The working AD records shall also be updated at the time of the cutover window.

### **3 Service termination of a ported number**

- 3.1 A ported number shall be regarded as relinquished only when the customer has terminated service with the RNO for more than 3 months.
- 3.2 If a ported number is relinquished, the ported number will be returned to the Original DNO. This will be achieved by the RNO passing an Advice of Relinquished Ported Number (ARPN) to the original DNO and other Network Operators. The Original DNO will then be responsible for providing appropriate call handling treatment for that number in the same manner as other non-ported numbers.
- 3.3 Before the Original DNO assigns a relinquished number to a customer, it should ensure that at least one regular AD cross-auditing cycle has been completed successfully.

### **4 Successive porting of a number**

- 4.1 For a customer wishing to port the number from an old RNO to a new RNO, the procedures will be similar to those of initial porting of the number. The same procedures as specified in sections 1 and 2 above shall be followed. The new RNO will become the "Recipient Network Operator" and the old RNO will become the "Donor Network Operator". If a successive ported number eventually ceases to be used by that customer of the new RNO and thus the number is relinquished, the ported number will be returned to the Original DNO (see Section 3 above). For successive porting, if the SCAPN of the previous porting related to the same DN had not been received by the DNO, the DNO should send out the NTNPR after checking its AD records.
- 4.2 The procedure for porting back to the Original DNO should be similar to a normal porting case, except that the directory number should no longer be classified as a working ported number in the GN databases and the ADs.

**Figure 1A**

**Normal MNP Porting Procedure (NPR issued in Morning Session)**

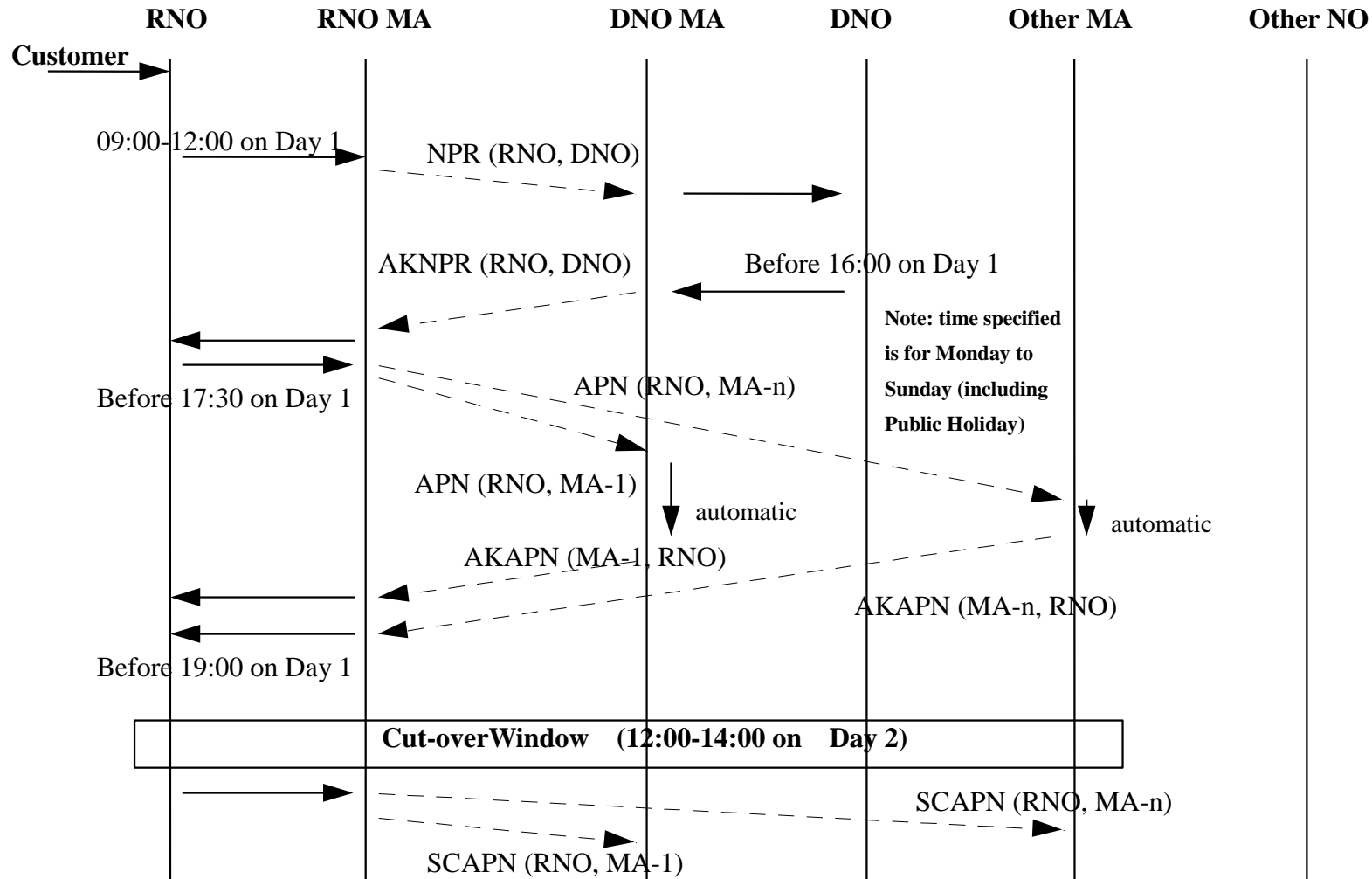

MNPPOR1a.ppt

Figure 1B

**Normal MNP Porting Procedure (NPR issued in Afternoon Session)**

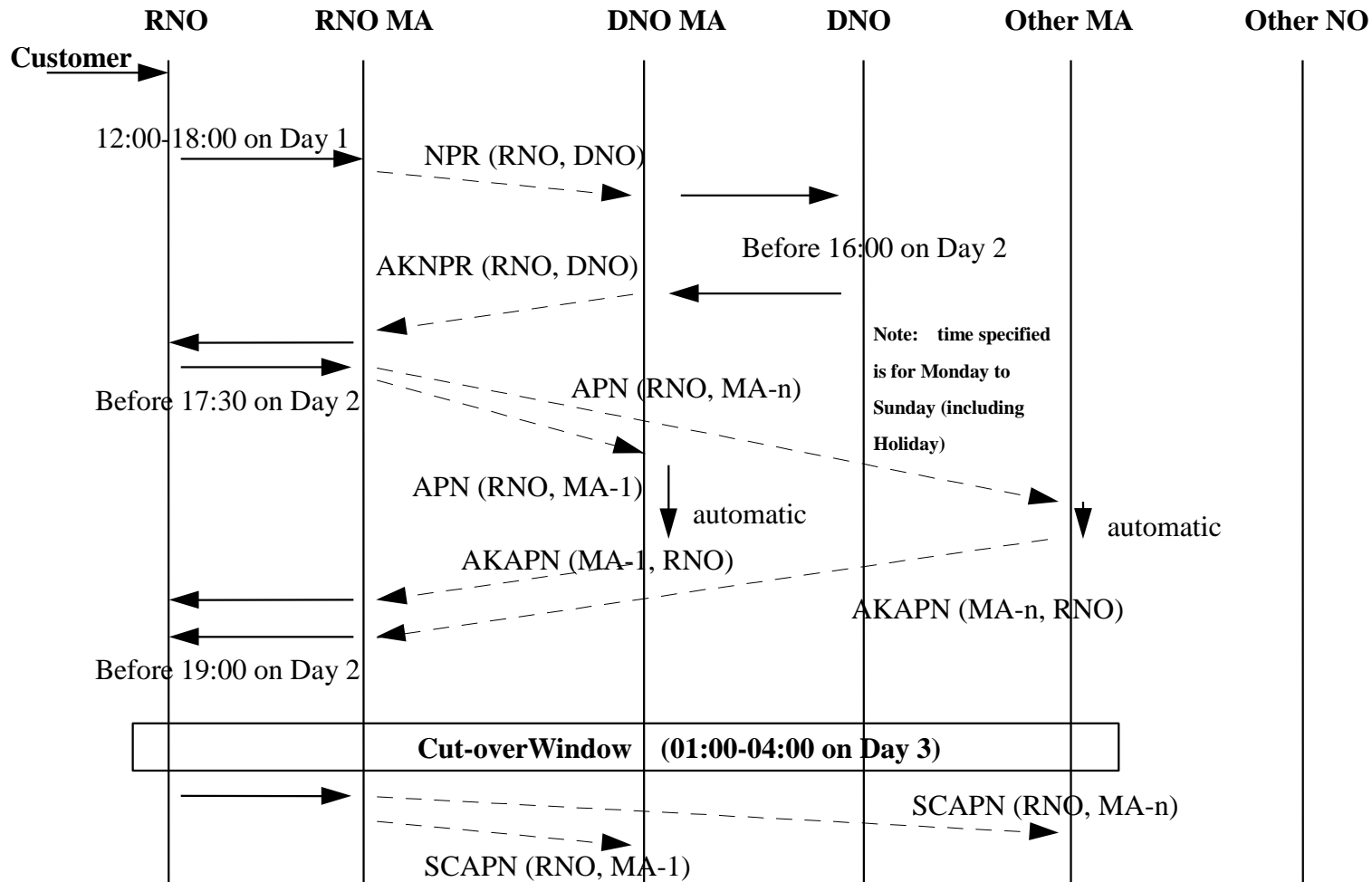

MNPPOR1b.ppt

Figure 2

## Normal MNP Port-back Procedure

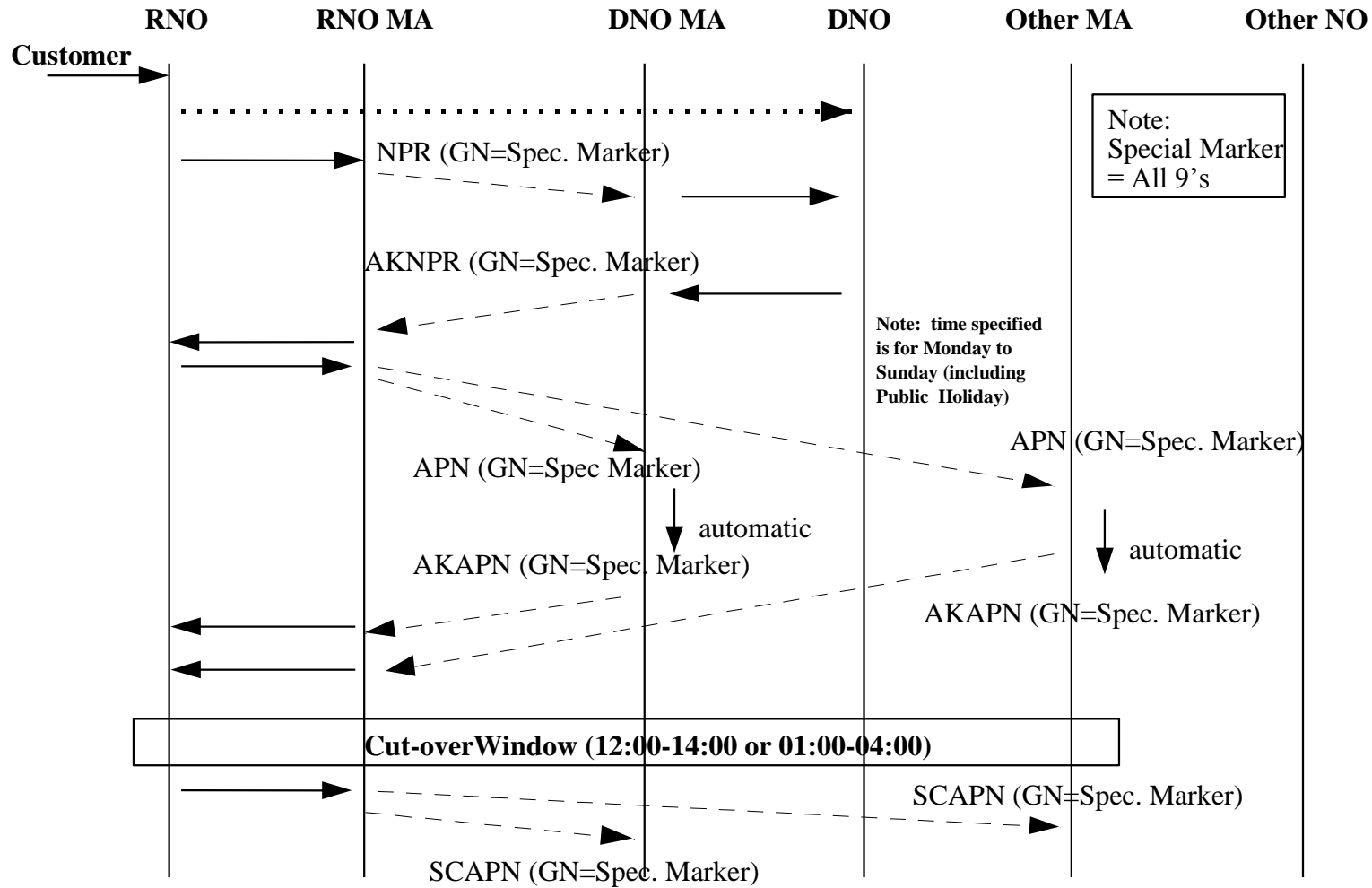

MNPPOR2.ppt

Figure 3

## Normal MNP Procedure for Relinquishment of Ported Number

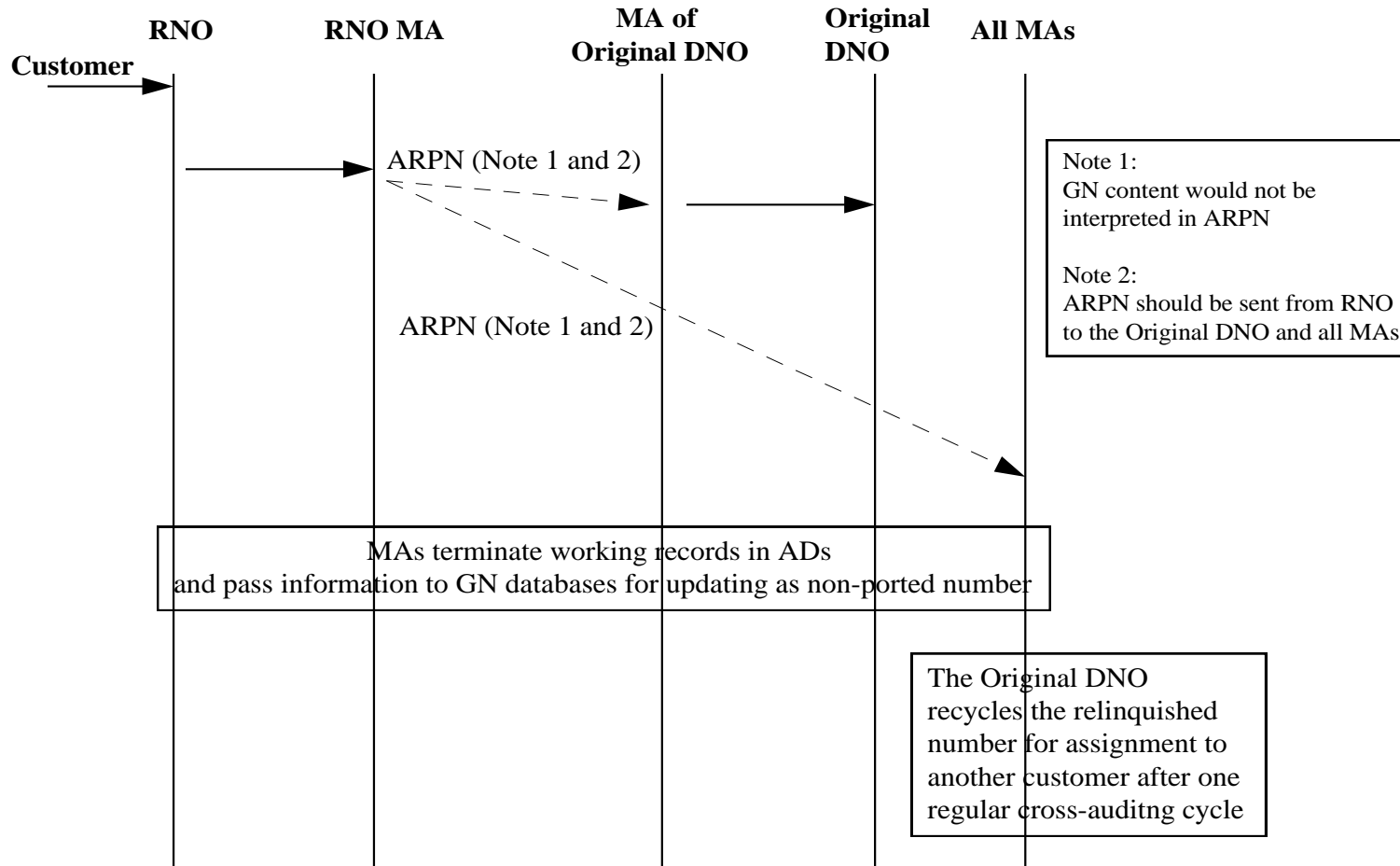

MNPPOR3.ppt

5. Message details for Normal MNP Porting Procedure

a. Message Flow and INF content for Negotiation Phase

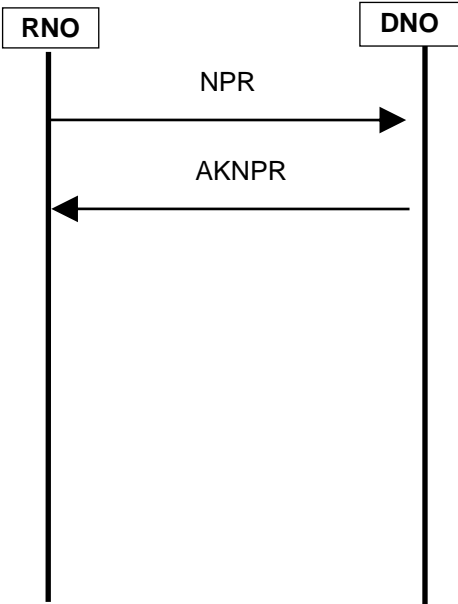

	NPR for Number Porting	AKNPR for Number Porting
IED Type	[ ✂ ]	
DN		
GN (Note 1)		
RNO		
DNO		
ODNO		
OTS		
ETS		
change_over_start_date		
change_over_start_time (Note 2)		
change_over_end_time (Note 2)		
rnodno_reference_serial		
Name		
ID # / Passport #		
comment		

Note 1: [ ✂ ]

Note 2: [ ✂ ]



**b. Message Flow and INF content for Provisioning Phase and Completion Phase**

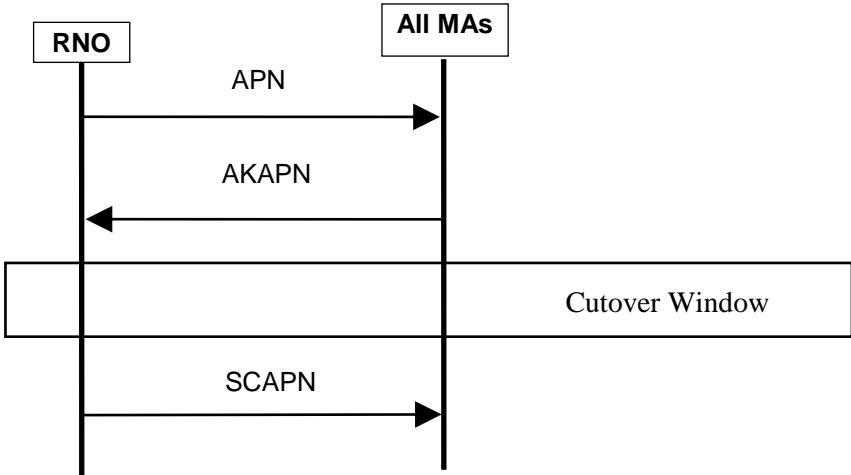

	APN for Number Porting	AKAPN for Number Porting	SCAPN for Number Porting
IED Type	[ ✂ ]		
DN			
GN (Note 1)			
RNO			
DNO			
ODNO			
OTS			
ETS			
Change_over_start_date			
Change_over_start_time (Note 2)			
Change_over_end_time (Note 2)			
Rnodno_reference_serial			
Comment			

**Note 1:** [ ✂ ]

**Note 2:** [ ✂ ]

c. Record status after Cut-over of number porting

	Working
DN	[ ✂ ]
GN	
RNO	
DNO	
ODNO	
OTS	
ETS	
change_over_date	
termin_date	
rnodno_reference _serial	

## **ANNEX 2**

# **Procedures for Change of Gateway Number**

**1. Introduction**

- 1.1 This Annex describes the message and record details for GN change by individual RNO (assuming that the two-byte network codes of Operators B, E and I are “OB”, “OE” and “OI” respectively).
- 1.2 After the GN change, the content of the new working record in the AD will be the same as the old working record except the GN field and the RNO/DNO Reference Serial Number. The old working record will become a history record with the termination date equal to the date of GN change.

**2. Details of Initial Record (before GN change)**

**a. Message Flow and INF content**

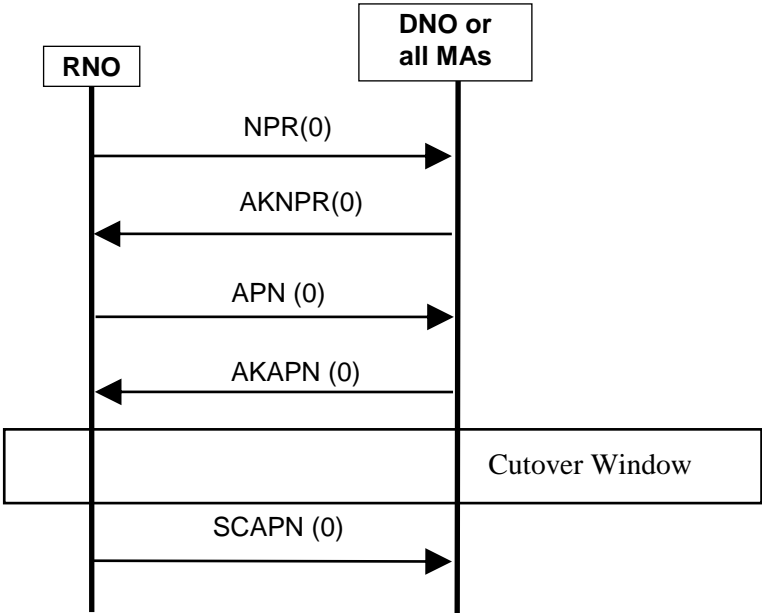

	SCAPN (0) for Number Porting
IED Type	[ ✂ ]
DN	
GN	
RNO	
DNO	
ODNO	
OTS	
ETS	
change_over_start_date	
change_over_start_time	
change_over_end_time	
rnodno_reference_serial	
comment	

**b. Record status after Cut-over of number porting**

This initial record applies to the subsequent GN change scenarios.

	<b>Working</b>
<b>DN</b>	[ ✂ ]
<b>GN</b>	
<b>RNO</b>	
<b>DNO</b>	
<b>ODNO</b>	
<b>OTS</b>	
<b>ETS</b>	
<b>change_over_date</b>	
<b>termin_date</b>	
<b>rnodno_reference _serial</b>	

3. Normal Process for GN Change

a. Message Flow and INF content

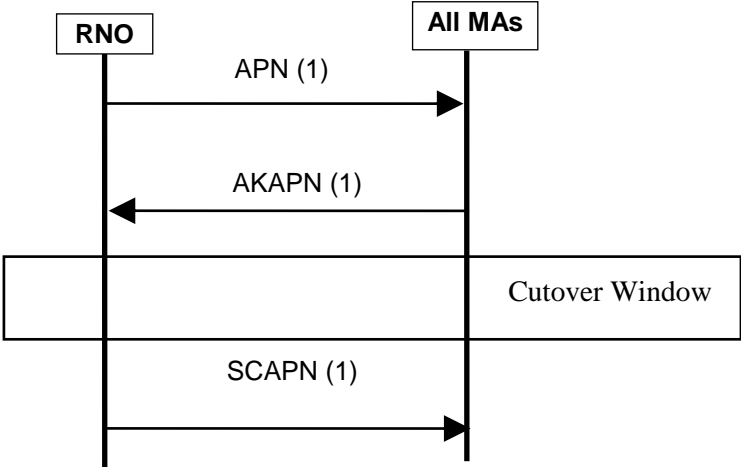

	APN (1) for Change of Gateway Number	AKAPN (1) for Change of Gateway Number	SCAPN (1) for Change of Gateway Number
IED Type	[ ✂ ]		
DN			
GN			
RNO			
DNO			
ODNO			
OTS			
ETS			
change_over_start_date			
change_over_start_time			
change_over_end_time			
rnodno_reference_serial			
comment			

**b. Records Status before Cut-over of GN Change in AD**

Type of record	GN Change
Working (refer to 2b)	[ ✂ ]
In-progress	

**c. Records Status after Cut-over of GN Change in AD**

	Working
DN	[ ✂ ]
GN	
RNO	
DNO	
ODNO	
OTS	
ETS	
change_over_date	
termin_date	
rnodno_reference _serial	

	History
DN	[ ✂ ]
GN	
RNO	
DNO	
ODNO	
OTS	
ETS	
change_over_date	
termin_date	
rnodno_reference _serial	

**4. Audit**

All working and history records of 1-month old including those records such as [ ✂ ], [ ✂ ] etc batch serial reference, are to be collected by the audit file.

## **ANNEX 3**

# **Procedures for Relinquishment of Ported Number**



**1. Introduction**

- 1.1 This Annex describes the message and record details for Relinquishment of ported number which has been stopped service for more than three months in the RNO (assuming that the two-byte network codes of Operators B, E and H are “OB”, “OE” and “OH” respectively).
- 1.2 After the relinquishment, the working record will become a history record with the termination date being set to the date of the relinquishment.

**2. Details of Successive Porting Record (before Relinquish)**

**a. Message Flow and INF content**

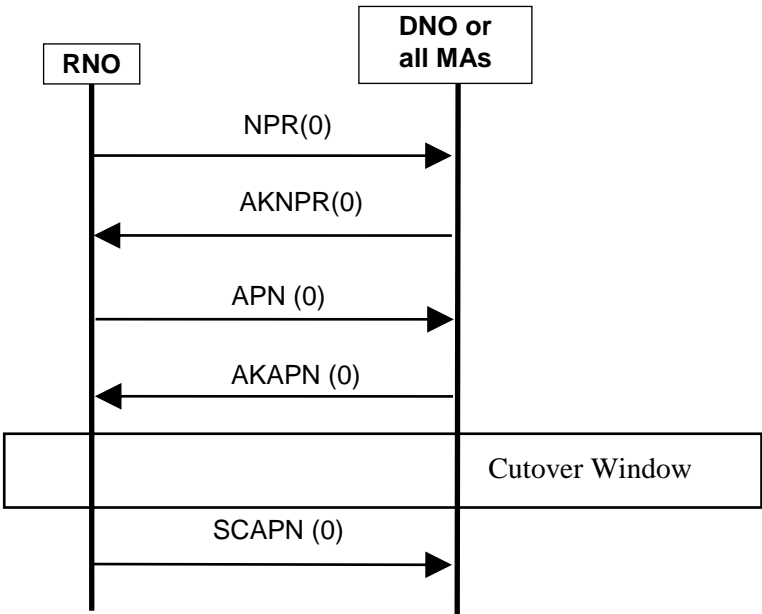

	SCAPN (0) for Number Porting
IED Type	[ % ]
DN	
GN	
RNO	
DNO	
ODNO	
OTS	
ETS	
change_over_start_date	
change_over_start_time	
change_over_end_time	
rnodno_reference_serial	
comment	

**b. Record status after Cut-over of number porting**

This working record applies to the subsequent Relinquish scenarios.

	<b>Working</b>
<b>DN</b>	[ ✂ ]
<b>GN</b>	
<b>RNO</b>	
<b>DNO</b>	
<b>ODNO</b>	
<b>OTS</b>	
<b>ETS</b>	
<b>change_over_date</b>	
<b>termin_date</b>	
<b>rnodno_reference _serial</b>	

3. Normal Process for Relinquish

a. Message Flow and INF content

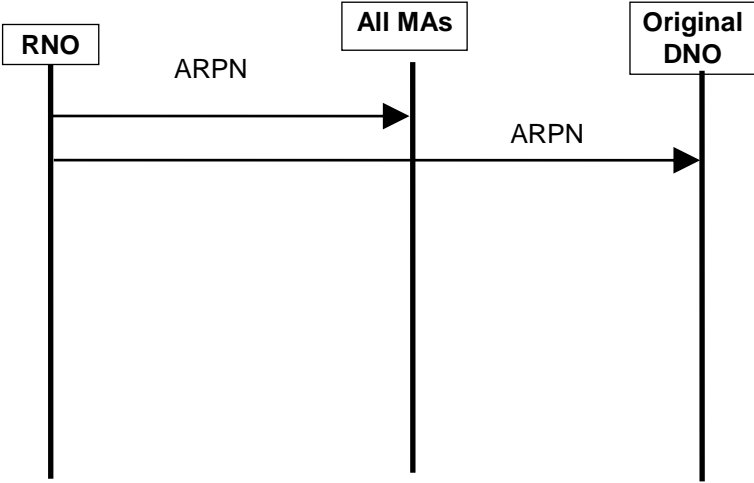

	ARPN
IED Type	[ ✂ ]
DN	
GN	
RNO	
DNO	
ODNO	
OTS	
ETS	
change_over_start_date	
change_over_start_time	
change_over_end_time	
rnodno_reference_serial	
comment	

b. Records Status after Relinquish in AD

	History
DN	[ ✂ ]
GN	
RNO	
DNO	
ODNO	
OTS	
ETS	
change_over_date	
termin_date	
rnodno_reference_serial	

4. Whenever the ONO or RNO detected irregularity in the APRN records, the ONO or RNO should advise the ODNO within 2 working days. The ODNO was responsible for coordinating with other operators to resolve the problem.

- End of Document -